

**ZETTLER**

# Visual Alarm Devices

Application Guide



# European Standard EN54-23

## Where to use Visual Alarm Devices

### Contents

Europe Standard EN54-23	01
Where to use VADs	02
Definitions	02
What is EN54-23?	02
Design Considerations	04
Ambient Light	04
Field of View	06
Reflective Surfaces	06
Zettler VADs	08
Ceiling Mounted	08
Wall Mounted	10
Using VADs in Spaces with Obstacles	14
Power Supplies and Wiring	16



Over recent years, the installation of Visual Alarm Devices (VADs) has experienced considerable growth since their mandatory introduction from 1st January 2014. This is in response to both the Equalities Act 2010 (UK only) and historical data which clearly demonstrates the effectiveness and reliability of VADs.

VADs are required to be used, in specific circumstances, in conjunction with other alarm devices to provide an effective means of alerting and evacuating occupants of a building. It is essential that the use of VADs forms part of the overall fire safety strategy. This strategy is based on an agreed building evacuation plan which, in turn, is a product of the buildings fire risk assessment.

Initially, before commencing any system design, it's advisable to carry out a fire risk assessment of the area to determine if VADs are required. If there is no requirement then, in addition to EN54-3 compliant sounders, Visual Indicating Devices (VIDs) would be a supplementary requirement to raise an event awareness.

Although EN54-23 has no definitive guidance with regards to how a risk assessment is carried out, the outcome of such an assessment may impact possible alarm solutions. For a more in-depth understanding of fire risk assessment please review the training section at [www.fia.uk.com](http://www.fia.uk.com).

Local Building Regulations Part M, BS5839-1, Loss Prevention Code of Practice - CoP0001, BS9999 and BS8300 recommend that VADs should be installed in places where audible devices alone would be ineffective, or where they are simply undesirable.

#### Applications where VADs would be typically installed are:

- As a visual warning for persons with impaired hearing (deaf or hard of hearing).
- Areas or places where people are likely to be on their own.
- Where hearing protection is being worn or areas where ambient noise exceeds 85dBA - (factories, production, workshops, machine rooms etc.)

**Please note:** In industrial and manufacturing areas it is essential to ensure that the visual fire alarms are clearly distinguishable from any other visual signals used for machine or process alarms.

- Bedrooms/sleeping areas in accommodation such as hotels, student accommodation, HMOs.

**Please note:** These devices are not intended to wake sleeping people. In these circumstances more effective methods should be considered, such as vibrating devices.

- Broadcasting studios of television, radio and recording.
- Nursing Homes.
- Hospitals (operating theatres) for which guidance is given in HTM 05-03 Part B.

- Toilet facilities, including all types and not limited to accessible/assisted areas.

- Fire Alarm systems using Gaseous Extinguishing systems – indication of first stage alarm (see BS 7273-1).

- To avoid unnecessary disruption from false alarms.

- Cinemas and Theatres Building where phased fire evacuation strategy is employed such as shopping malls, high rise or large buildings, hospitals.

- Public assembly buildings and entertainment complexes. Here staff only warning systems could utilise VADs as an initial alarm prior to a full evacuate signal.

# Definitions



For the purposes of this document we have used the terms and definitions given in EN54-23 and BS5839-1 along with the Royal National Institute for Deaf people (RNID) and the Royal Association for Deaf people (RAD) are as follows:

### Hard of Hearing Person

A person who can only hear above 25 dBA but can hear sounds less than 80 dBA.

### Deaf Person

A person who cannot hear sounds less than 80 dBA.

### Ambient Light Level

The ambient light level typically present in an area of a building, which is likely to vary over the course of a day, is taken into consideration when designing a VAD installation.

### Combined VAD

A VAD combined with another fire detection device and fire alarm system. For example, combined VAD and alarm sounder, or VAD and smoke detector.

### Photosensitive Epilepsy

Recurrent convulsions precipitated by visual stimuli, particularly flickering light seizures are most likely to be triggered by frequencies between 3 Hz and 30 Hz, although this varies from person to person it is unlikely that seizures are triggered at frequencies less than 3 Hz.

# So What Is EN54-23?

The European Committee for Standardization, CEN released EN54-23, a new mandatory standard from 1st January 2014. Prior to its release, no EN standard existed for visual alarm devices. Therefore, misinterpretation and confusion over a product's performance was a common concern in the industry. 'Beacons' are inconsistent and not always fully fit for purpose.

Outputs can be stated in many different units of measurement, i.e Joules, Candela or Watts. EN54-23 provides clarity, standardizes the requirements, test methods and performance criteria of VADs and ensures light output is now measured in a uniform manner throughout Europe.

### Main Requirements from EN54-23 are:

- The coverage volume (i.e. volume within which required illumination is achieved) must be stated on the product or in supporting documentation.
- VAD shall meet the requirement for coverage volume of at least one of the following categories: W (Wall), C (Ceiling), O (Open Class).
- Required illumination of 0.4 lux on a surface perpendicular to the direction of the light emitted from the VAD.
- The rate of flash should be stated between 0.5Hz and 2Hz.
- The devices are classified as Type A for indoor purposes, and Type B, for outdoor applications.
- Access to the device shall be restricted by the use of special screws or tools.
- It should not be possible to change the manufacturer's settings without use of the same screws/tools, or by breaking a seal. Adjustments may be carried out either at the device or via the control and indicator equipment.

# Wall Category

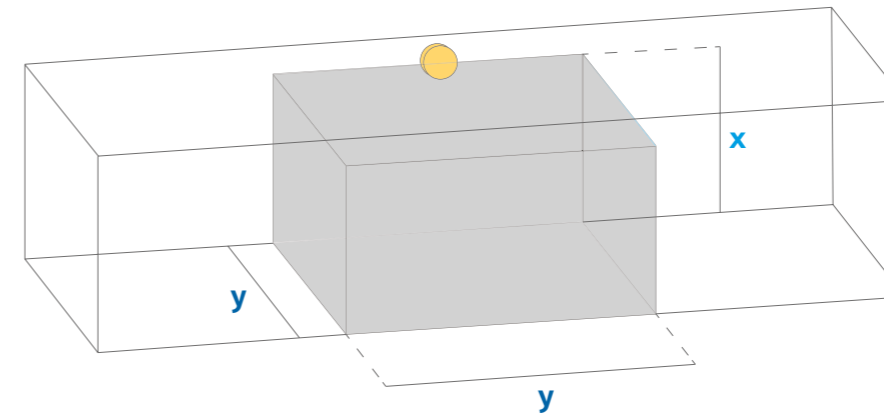

### Coverage volume code:

**W - (x) - (y)**

**W = wall mounted**

**x** = maximum mounting height

**y** = length and width in metres of the cubic volume covered (to a minimum level of 0.4 lux) when the device is mounted to the wall at a height of **x**

# Ceiling Category

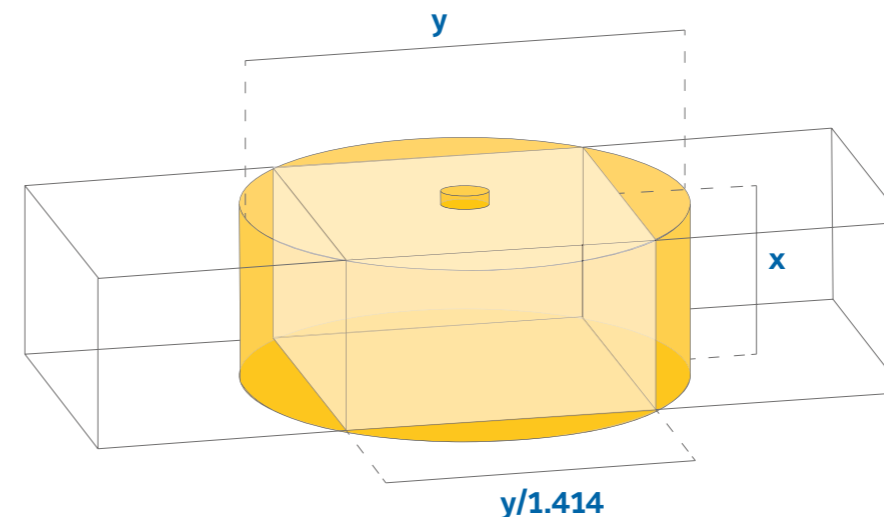

### Coverage volume code:

**C - (x) - (y)**

**C = ceiling mounted**

**x** = maximum mounting height

**y** = diameter in metres of the cylindrical volume covered (to a minimum level of 0.4 lux) when the device is mounted to the ceiling at a height of **x**

# Open Class Category

The coverage volume and its shape are specified by the manufacturer and include mounting position and orientation alongside any restriction on the mounting height.



# Design Considerations

When designing a fire detection and alarm system, and where VADs are required, the following should be considered:

- Ambient light level.
- Field of view.
- Reflective surfaces.
- Use of tinted eye protection.
- The environment - indoor Type A devices – IP21C, outdoor Type B devices – IP33C.
- Applications where there is continuous surveillance of a VAD in a specific direction may not require widespread coverage. For example, a seated auditorium or a broadcast studio may only require limited coverage.
- Where possible, locate the VADs for direct viewing for all occupants in an area. If this is not possible, consider the minimum illumination on adjacent reflected surfaces.
- If relying on indirect illumination, the reflecting surfaces should be within the coverage area of the VAD.

- Where a coverage area is larger than that of a single VAD, an appropriate number of extra VADs should be installed.

- Dependence on direct line of sight should not be relied upon if the VAD is used where deaf or hard-of-hearing people may be alone for prolonged periods. This particularly applies to hotel bedrooms and bathrooms. It also relates to people wearing ear defenders, or where they may be working alone or focusing on a specific activity.

- In the case of stairwells, the illumination from a VAD should satisfy the recommendations across the area of each landing. Compliance may not be necessary throughout the entire stairway.

## Ambient Light Level

The ambient light level in the vicinity of a VAD will affect its visibility and, therefore its ability to provide effective warning. In designing the installation, consideration should be given to the variation of the ambient light level during the periods when the VADs are intended to be effective in giving a warning of fire.

The extent of artificial lighting in combination with any natural lighting will affect the ambient light level. This level can also be influenced by external natural light conditions such as bright sunshine, daylight, overcast sky, twilight and moonlight, and may be reduced by measures such as blinds or curtains on windows.

Information on the recommended illumination in workplaces and typical ambient light levels is given in Tab. 1 below. However, this is for guidance only and it is important that ambient light levels are measured correctly for each application.

Always consider the highest possible ambient light level which may exist for each specific application. In general, the coverage volume of VADs may be increased in low ambient light levels but may need to be decreased for brightly lit spaces or in spaces that can be flooded by strong daylight, such as rooms with south-facing windows.

Category	Recommended Illumination (lux)			Example
	Low	Medium	High	
General areas that are not in permanent use or that do not demand a high visibility for the task	20	30	50	Rooms not in permanent use Short term use Public areas
	50	100	150	
	100	150	200	
General lighting for indoor work	200	300	500	Operation of machinery Offices Difficult to see detail (e.g. quality control)
	300	500	750	
	500	750	1000	
Task lighting for highly demanding work	750	1000	1500	Demanding visual task undertaken for extended time (e.g. watch making) Fine detailed assembly
	1000	1500	2000	
		>2000		

Note: These recommendations are derived from visibility tests. They are applicable for mid-aged persons, medium reflectance in the visual environment and for normal priority tasks.

Tab. 1 Recommended illumination in various ambient environments

Tab. 2 gives multiplication factors (based on CoP 0001 clause 4.6.9.3) that can be applied to the coverage distance for devices approved to EN 54-23, as declared by the manufacturers. These multiplication factors should only be used after careful consideration of the application, including prevalent ambient light level and the need to rely on indirect rather than direct illumination. Tab. 2 covers ambient light up to 800 lux. For ambient light levels above 800 lux it is recommended that either the manufacturer of the VAD or a lighting specialist is consulted in the design of the application.

Ambient light level (lux)	Ceiling mount direct view	Ceiling mount indirect view	Wall mount direct view	Wall mount indirect view
<100	2.8	1.3	5.2	1.8
100 to 200	2.4	1.2	4.4	1.7
200 to 300	1.9	1.0	3.2	1.4
300 to 400	1.4	0.8	2.3	1.2*
400 to 500	1.1	0.6	1.8	1.0
500 to 600	0.9	0.5	1.3	0.9
600 to 700	0.7	0.4	1.0	0.7

Tab. 2 Coverage distance multiplication factors for VADs

For example, a VAD with the EN 54-23 rating of W-2.4-7.5 is to be used in a location where it will be mounted on the wall. Here, the maximum ambient light level is 350 lux, and the viewing method is considered to be indirect. Tab. 2 gives a factor of 1.2 for these conditions. The coverage of the VAD, being a square of 7.5m side, is multiplied by the factor 1.2 to give a revised coverage of 9m. The height rating of 2.4m may also be multiplied by 1.2 giving a revised coverage of 2.88m. The VAD may therefore be used in this location as its rating is W-2.88-9.



## Reflective Surfaces

Some surfaces may reflect or absorb light, so it is important to assess and understand the installed surface materials as different types will react differently to the emitted light.

The reflection of light may be specular when the entire incident light is reflected in one direction from a shining surface, e.g. glass mirror, polished metal or gloss paint, or it may diffuse when the light is reflected in many directions from an uneven or granular surface. The reflective characteristic of most materials is such that they will exhibit both specular and diffuse reflections.

Reflective surfaces can increase the effective field of vision of the occupants in the protected area by providing multiple paths for the light to attract their attention. In assessing this, care should take into account only permanent reflective structures and the degree of specular reflection that will be given by the surfaces involved.

### Field of View

Consideration should be given to the presence of any obstructions, such as partitions or furniture that could affect the actual VAD coverage. At any position within a space where a VAD is required, any individual should be able to view its light directly or reflected from adjacent surfaces.

## Ceiling Mounted



Ceiling mounted VADs are suitable for broad coverage in regular shaped rooms. They can be used as an alternative to wall mounted devices and are more practical to install in large open areas as they can be combined with detection devices. However, they are more likely to be affected by higher ambient light levels.

Tab. 3 below shows the technical details about the ZETTLER addressable ceiling VAD bases.

Part Number	Model Name	Description	Coverage Volume	Flash Rating	Body Colour	Flash Colour	IP Rating
576.080.006	P80AVB	Addressable Base Sounder VAD White LEDs Standard Power	C-3-8	0.5 / 1 Hz	Clear	White	IP21C
576.080.014	P81AVB	Addressable Base Sounder VAD White LEDs High	C-3-15	0.5 / 1 Hz	Clear	White	IP21C

Tab. 3 ZETTLER ceiling mounted VADs data

Tab. 4 and 5 show volume coverage for ZETTLER ceiling-mounted VADs with direct and indirect viewing and ambient light correction

Uncorrected VAD rating	Ambient light level (lux) Multiplication factors corrected figures for direct viewing							
	<100	100 to 200	200 to 300	300 to 400	400 to 500	500 to 600	600 to 700	700 to 800
C-3-8	C-8.6-22.4	C-7.2-19.2	C-5.7-15.2	C-4.2-11.2	C-3.3-8.8	C-2.7-7.2	C-2.1-5.6	C-1.5-4
C-3-15	C-8.6-42	C-7.2-36	C-5.7-28.5	C-4.2-21	C-3.3-16.5	C-2.7-13.5	C-2.1-10.5	C-1.5-7.5

Tab. 4 Volume coverage for ZETTLER ceiling-mounted VADs with direct viewing and ambient light correction

Uncorrected VAD rating	Ambient light level (lux) Multiplication factors corrected figures for direct viewing							
	<100	100 to 200	200 to 300	300 to 400	400 to 500	500 to 600	600 to 700	700 to 800
C-3-8	C-3.9-10.4	C-3.6-9.6	C-3-8	C-2.4-6.4	C-1.8-4.8	C-1.5-4	C-1.2-3.2	C-0.9-2.4
C-3-15	C-3.9-19.5	C-3.6-9.6	C-3-15	C-2.4-12	C-1.8-4.8	C-1.5-4	C-1.2-6	C-0.9-4.5

Tab. 5 Volume coverage for ZETTLER ceiling-mounted VADs with indirect viewing and ambient light correction

# Examples of Ceiling VAD Siting

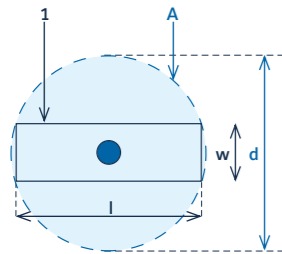

## Single ceiling-mounted VAD in a corridor

This single circle shows the use of ceiling mounted VADs in corridors. A single ceiling-mounted VAD is used to cover the length of the corridor.

In this case, for an area with a ceiling height of up to 3m, a VAD with a specified coverage range of C-3-d where  $d = \sqrt{l^2 + w^2}$  will be suitable. The required minimum illumination will be achieved for the area contained within the space defined by the circle A with a diameter d.

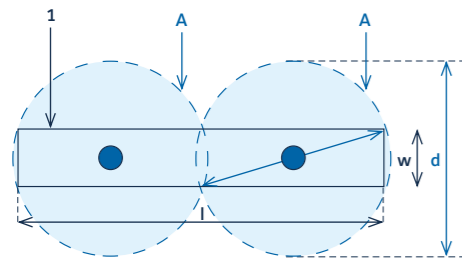

## Several ceiling-mounted VADs in a corridor

The double circles show two ceiling-mounted VADs with a specified coverage range of C-3-d where  $d = \sqrt{(0.5 \times l)^2 + w^2}$  will be suitable.

This means that all points in the space contained in the corridor with a  $l \times w$  area will achieve the minimum required illumination as they are contained within the space defined by circles A with a diameter d.

Where the length does not contain an exact number of widths, a number of circles with greater overlapping may be needed to calculate coverage.

Using a 0.5Hz flash rate reduces the current consumption. When installing more than one device in the same area all devices should be set to the same flash rate.

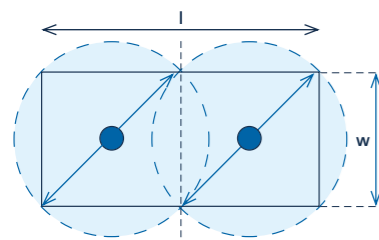

## Two ceiling-mounted VADs in an oblong room

The double circles show two ceiling-mounted VADs with a specified coverage range of C-3-d where  $d = \sqrt{(0.5 \times l)^2 + w^2}$  will be suitable.

All points in the room with a  $l \times w$  area will achieve the minimum required illumination as they are contained within the space defined by circles A with a diameter d. Where the length does not contain an exact number of widths, a number of circles with greater overlapping may need to be used in calculating coverage.

Using a 0.5Hz flash rate reduces the current consumption. When installing more than one device in the same area all devices should be set to the same flash rate.

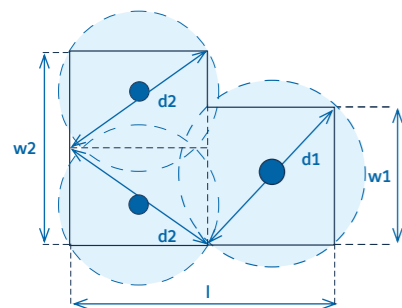

## Several ceiling-mounted VADs in an L-shaped room

The diagram above which shows an L-shaped room that can be covered by several ceiling VADs mounted central to each virtual space and having adequate coverage distance similar to implementing a single ceiling VAD where the diameter of the coverage area is  $d1$  or  $d2$ .

Using a 0.5Hz flash rate reduces the current consumption. When installing more than one device in the same area all devices should be set to the same flash rate.



# Examples of Wall VAD Siting



Wall mounted VADs are likely to be effective in a wide range of applications. They are suitable for higher ambient light levels and the preferred choice for general applications.

Tab. 6 below shows the technical details about the ZETTLER addressable wall mounted VADs.

Part Number	Model Name	Description	Coverage Volume	Flash Rating	Body Colour	Flash Colour
576.080.007	P80AVW	Addressable Wall Sounder VAD White	W-2.4-7.5	0.5 / 1 Hz	White	White
576.080.008	P80AVR	Addressable Wall Sounder VAD Red Power	W-2.4-7.5	0.5 / 1 Hz	Red	White
576.080.009	P80AVR	Addressable Wall Sounder VAD IP Red	W-2.4-7.5	0.5 / 1 Hz	Red	White

Tab. 6 ZETTLER wall mounted VADs data

Tab. 7 and 8 show volume coverage for ZETTLER wall mounted VADs with direct and indirect viewing and ambient light correction

Uncorrected VAD rating	Ambient light level (lux) Multiplication factors corrected figures for direct viewing						
	<100	100 to 200	200 to 300	300 to 400	400 to 500	500 to 600	600 to 700
W-2.4-7.5	W-12.48-39	W-10.56-33	W-7.68-24	W-5.52-17.25	W-4.32-13.35	W-3.12-9.75	W-2.4-7.5

Tab. 7 Volume coverage for ZETTLER wall mounted VADs with direct viewing and ambient light correction

Uncorrected VAD rating	Ambient light level (lux) Multiplication factors corrected figures for direct viewing						
	<100	100 to 200	200 to 300	300 to 400	400 to 500	500 to 600	600 to 700
W-2.4-7.5	W-4.32-13.5	W-4.08-12.75	W-3.36-10.5	W-2.88-9	W-2.4-7.5	W-2.16-6.75	W-1.68-5.25

Tab. 8 Volume coverage for ZETTLER wall mounted VADs with indirect viewing and ambient light correction

## Single wall-mounted VAD in a corridor

The above diagram shows how a corridor ( $l$  multiplied by  $w$ ) may be covered by one wall-mounted VAD centrally sited on one wall at a height of  $h$ .

The following applies:

- Where the length of the corridor is greater than the width, a VAD with a specified coverage range of  $W-h-y$  where  $y = l$  will be suitable.
- Where the length of the corridor is smaller than the width, a VAD with a specified coverage range of  $W-h-y$  where  $y = w$  will be suitable.

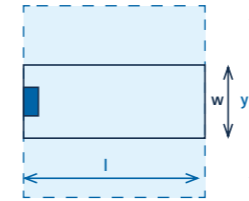

## Double wall-mounted VADs in a corridor end to end

This diagram shows how a corridor ( $l$  multiplied by  $w$ ) may be covered by two wall-mounted VADs centrally sited on opposite ends at a height of  $h$ . The following applies: Two VADs with a specified coverage range of  $W-h-y$  where  $y = l/2$  will be suitable.

Using a 0.5Hz flash rate reduces the current consumption. When installing more than one device in the same area all devices should be set to the same flash rate.

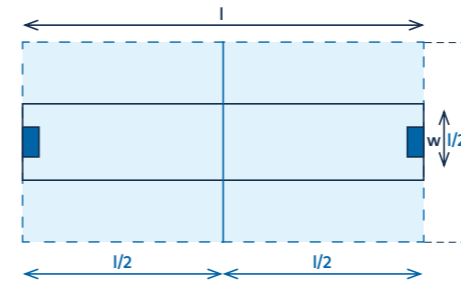

## Double wall-mounted VADs in a corridor side wall

The above shows how a corridor ( $l$  multiplied by  $w$ ) may be covered by two wall-mounted VADs sited on a side wall at a height of  $h$ . The following applies:

- Two VADs with a specified coverage range of  $W-h-y$  where  $y = l/2$  will be suitable.
- Each VAD should be mounted at distance  $l/4$  from each end.

Using a 0.5Hz flash rate reduces the current consumption. When installing more than one device in the same area all devices should be set to the same flash rate.

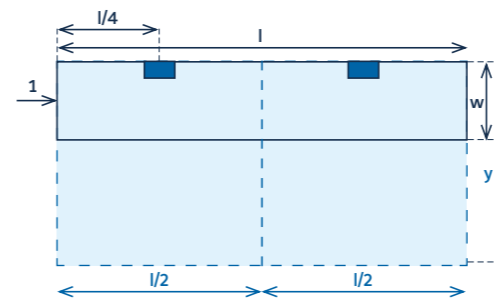

## Double wall-mounted VADs in a corridor opposing walls

This example shows how VADs can be mounted on opposing walls to provide better direct illumination for occupants exiting rooms (e.g. hotel bedrooms) from either side of the corridor.

Using a 0.5Hz flash rate reduces the current consumption. When installing more than one device in the same area all devices should be set to the same flash rate.

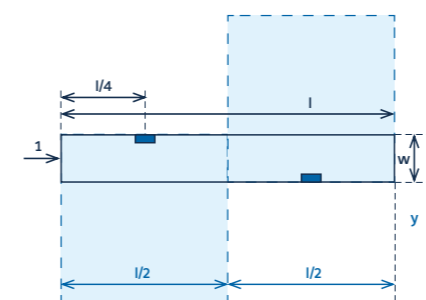

# Examples of Wall VAD Siting

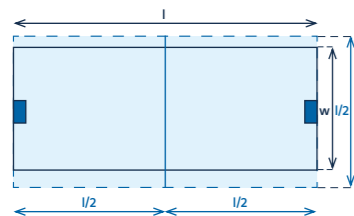

## Two wall-mounted VADs in an oblong room

The above room dimensions ( $l$  multiplied by  $w$ ) where the width is less than half the length may be covered by two wall-mounted VADs sited at the height of  $h$ .

The following applies:

- Two VADs with a specified coverage range of  $W-h-y$  where  $y = l/2$  mounted on opposite walls will be suitable
- Two VADs with a specified coverage range of  $W-h-y$  where  $y = l/2$  mounted at the  $1/4$  distance of the longest wall and on opposite side will be suitable

Using a 0.5Hz flash rate reduces the current consumption. When installing more than one device in the same area all devices should be set to the same flash rate.

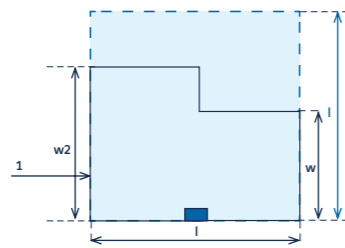

## Single wall VAD coverage in an L-shaped space

The diagram shows how wall-mounted VADs can be used to cover an L-shaped room of length  $l$ , minimum width  $w1$  and maximum width  $w2$ .

The diagram shows a single wall-mounted VAD with a coverage distance of  $W-h-l$  where  $h$  is the maximum height at which the device is mounted and  $l$  is the width in metres of the cuboid which contain the L-shaped space. All points in the L-shaped room will achieve the minimum required illumination of 0.4 lux as they are contained within the space defined by the maximum coverage distance of the VAD, i.e.  $l$ .

Using a 0.5Hz flash rate reduces the current consumption. When installing more than one device in the same area all devices should be set to the same flash rate.

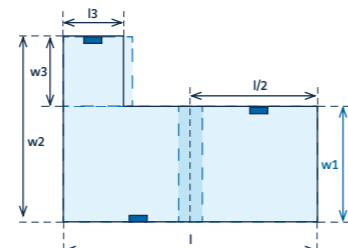

## Triple-wall VAD coverage in an L-shaped space

This L shape diagram shows how three wall-mounted VADs with smaller coverage distances can be used to cover the same L-shaped room by subdividing the room into a number of square areas. In this example, assuming that  $w1$  is greater than  $l/2$  and  $w3$  is greater than  $l3$ , three VADs may be used as follows:

- 2 x  $W-h-w1$  (the larger area)
- 1 x  $W-h-w3$  (the smaller area)

Our diagram also demonstrates how, by placing VADs on opposite walls, all occupants of the room can be in direct view of at least one of the VADs.

Using a 0.5Hz flash rate reduces the current consumption. When installing more than one device in the same area all devices should be set to the same flash rate.

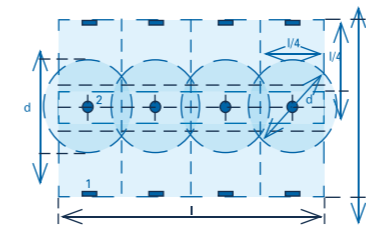

## Example of combining Wall and Ceiling VADs

In this example there are eight wall mounted VADs and four ceiling-mounted VADs. This shows how a mix of ceiling-mounted and wall-mounted VADs can be used to cover a large room.

The wall-mounted VADs have a coverage distance of  $W-h-l/4$  and the ceiling-mounted VADs have a coverage distance of  $C-h2-d$  where:

- $h1$  = the height of the VAD on the wall,
- $l/4$  = the length of a square division of the room,
- $h2$  = the height of the ceiling,
- $d$  = the diameter of the coverage circle of the ceiling-mounted VADs, calculated as

$$d = \sqrt{((l/4)^2 + (l/4)^2)}, \text{ assuming that } l/4 > w/3.$$

Using a 0.5Hz flash rate reduces the current consumption. When installing more than one device in the same area all devices should be set to the same flash rate.



## Using VADs in Spaces with Obstacles

Consideration should be given at the design stage to obstacles that affect the warning given by VADs by creating blind 'spots' with little or no direct or indirect illumination. These spaces can require a change to the number and position of VADs.

In rooms with obstacles which affect the illumination from VADs, one or both of the following should be applied:

- Sufficient numbers of VADs are installed so that any persons within the space between obstacles have a direct view of at least one VAD
- The VADs installed provide sufficient illumination of the obstacle surfaces to ensure adequate warning to occupants who do not have direct view of at least one VAD.

- In rooms where suspended items such as supply pipes and ducts (e.g. ventilation ducts) mask VADs from occupants, one or both of the following should be applied:

- Sufficient numbers of VADs are installed so that occupied areas of the room are adequately illuminated, and/or
- The VADs installed provide adequate illumination of surfaces that are adjacent to occupants of the room where those occupants do not have a direct view of at least one VAD.



# Power Supplies and Wiring

Power supplies should conform to EN54-4 and should be compliant with the recommendation of the local installation standards and code of practices. Both the normal and standby supply should be independently capable of supplying the maximum alarm load imposed by the system and the high peak-power requirements of any VADs connected to a system and should have no detrimental effect on the mandatory functions of the fire detection and alarm system.

Since VADs form part of the primary means for giving warning of fire, in particular circumstances it is essential that circuits on which they are connected operate correctly at the time of a fire.

## Disclaimer

The information provided in this brochure is provided for informational purposes only. The materials are general in nature; they are not offered as advice on a particular matter and should not be relied on as such. The materials contained in this brochure are the copyrighted property of Johnson Controls unless a separate copyright notice is placed on the material. ZETTLER and PROFILE are marks and/or registered marks. Unauthorized use is strictly prohibited. Graphics or images displayed are for visual purposes only and actual products may vary.

Therefore, cables with an inherent ability to resist flame and heat need to be used and compliance with BS 5839:1 sub-clause 26.2 is mandatory.

ZETTLER provides MZX designer software that allows the designer of the fire detection and alarm system to calculate the load, power requirements of individual loops in standby and alarm modes based on the devices connected and parameters such as loop length, resistance, devices types etc. This tool shall be used to validate the design of any ZETTLER fire detection and alarm system, including those where VADs are used.





# Global Strength. Local Expertise. At your service.

## Regional Offices EMEA:

### Austria (Bergheim)

Tel.: +43 (0) 662 45 24 60 11  
Fax: +43 (0) 662 45 24 60 09

### Hungary (Budapest)

Tel.: +36 (0) 148 113 83  
Fax: +36 (0) 120 344 27

### Sweden (Lammhult)

Tel.: +46 (0) 472 269 980  
Fax: +46 (0) 472 269 989

### Belgium (Drogenbos)

Tel.: +32 (0) 246 778 11  
Fax: +32 (0) 246 605 34

### Italy (Milan)

Tel.: +39 (0) 331 583 000  
Fax: +39 (0) 331 583 030

### Switzerland (Näfels)

Tel.: +41 (0) 584 454 000  
Fax: +41 (0) 584 454 301

### Czech Republic (Liberec)

Tel.: +420 (0) 482 736 291  
Fax: +420 (0) 482 736 293

### Norway (Lørenskog)

Tel.: +47 (0) 679 177 00  
Fax: +47 (0) 679 177 15

### The Netherlands (Capelle aan den IJssel)

Tel.: +31 (0) 882 602 600  
Fax: +31 (0) 882 602 345

### France (Paris)

Tel.: +33 (0) 148 178 727  
Fax: +33 (0) 148 178 720

### Russia

Tel.: +31 (0) 534 284 444  
Fax: +31 (0) 534 283 377

### Turkey (Ankara)

Tel.: +90 (0) 312 473 7011  
Fax: +90 (0) 312 473 7392

### Germany (Ratingen)

Tel.: +49 (0) 210 271 410  
Fax: +49 (0) 210 271 41100

### Spain (Madrid)

Tel.: +34 (0) 913 807 4 60  
Fax: +34 (0) 913 807 4 61

### United Arab Emirates (Dubai)

Tel.: +971 (0) 488 386 89  
Fax: +971 (0) 488 386 74

### United Kingdom & Ireland (Sunbury-on-Thames)

Tel.: +44 (0) 800 458 7999  
Fax: +44 (0) 844 800 2999

[www.zettlerfire.com](http://www.zettlerfire.com)

© 2018 Johnson Controls. All rights reserved.